

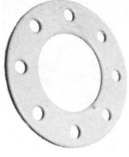





Backing Rings

AND DRESSING SETS

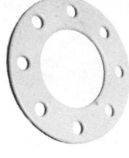
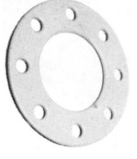
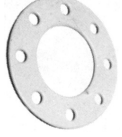
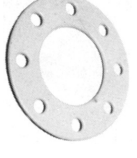
GALVANISED AND SS BACKING RINGS FOR PVC/ABS					
	Code	Size (NB) mm		Code	Size (NB) mm
Galvanised Backing Ring for ABS/PVC ANSI150 Drilling  <p>*ABS only</p>	FABSBRG150/015	15	Galvanised Backing Ring for uPVC Table D Drilling 	FUPVCBRGTD/225	225
	FABSBRG150/020	20		FUPVCBRGTD/250	250
	FABSBRG150/025	25			
	FABSBRG150/032	32			
	FABSBRG150/040	40			
	FABSBRG150/050	50			
	FABSBRG150/065	65			
	FABSBRG150/080	80			
	FABSBRG150/100	100			
	FABSBRG150/125	125			
Galvanised Backing Ring for ABS/PVC Table E Drilling  <p>*ABS only</p>	*FABSBRG150/150	150	Galvanised Backing Ring for uPVC Table E Drilling 	FUPVCBRGTE/125	125
	*FABSBRG150/200	200		FUPVCBRGTE/150	150
	FABSBRGTE/015	15		FUPVCBRGTE/175	175
	FABSBRGTE/020	20		FUPVCBRGTE/200	200
	FABSBRGTE/025	25		FUPVCBRGTE/225	225
	FABSBRGTE/032	32		FUPVCBRGTE/250	250
	FABSBRGTE/040	40		FUPVCBRGTE/300	300
	FABSBRGTE/050	50		FUPVCBRGTE/400	400
	FABSBRGTE/065	65			
	FABSBRGTE/080	80			
Galvanised Backing Ring for ABS/PVC BS4504 Drilling  <p>*ABS only</p>	FABSBRGTE/100	100	Stainless Steel Backing Ring for ABS/PVC Table E Drilling  <p>*ABS only</p>	FABSRSSTE/050	50
	FABSBRGTE/125	125		FABSRSSTE/080	80
	*FABSBRGTE/150	150		FABSRSSTE/100	100
	*FABSBRGTE/200	200		*FABSRSSTE/150	150
	*FABSBRGTE/250	250			
	*FABSBRGTE/300	300			
	FABSBRG4504/050	50			
	FABSBRG4504/065	65			
	FABSBRG4504/080	80			
	FABSBRG4504/100	100			
FABSBRG4504/125	125				

PP BACKING RINGS FOR INDUSTRIAL /MECHANICAL APPLICATIONS					
	Code	Size (OD) mm		Code	Size (OD) mm
Butt Fusion Backing Ring ANSI 150 Drilling 	FPPVBR150BF/090	90	Butt Fusion Backing Ring ISO/DIN Drilling 	FPPVBRDINBF/090	90
	FPPVBR150BF/110	110		FPPVBRDINBF/110	110
	FPPVBR150BF/160	160		FPPVBRDINBF/125	125
	FPPVBR150BF/200	200		FPPVBRDINBF/140	140
	FPPVBR150BF/225	225		FPPVBRDINBF/160	160
	FPPVBR150BF/250	250		FPPVBRDINBF/180	180
	FPPVBR150BF/280	280		FPPVBRDINBF/200	200
	FPPVBR150BF/315	315		FPPVBRDINBF/250	250
Socket Fusion Backing Ring ANSI 150 Drilling 	FPPVBR150SF/020	20	Socket Fusion Backing Ring ISO/DIN Drilling 	FPPVBRDINBF/280	280
	FPPVBR150SF/025	25		FPPVBRDINBF/315	315
	FPPVBR150SF/032	32		FPPVBRDINSF/020	20
	FPPVBR150SF/040	40		FPPVBRDINSF/025	25
	FPPVBR150SF/050	50		FPPVBRDINSF/032	32
	FPPVBR150SF/063	63		FPPVBRDINSF/040	40
	FPPVBR150SF/075	75		FPPVBRDINSF/050	50
	FPPVBR150SF/090	90		FPPVBRDINSF/063	63
	FPPVBR150SF/110	110		FPPVBRDINSF/075	75
	FPPVBR150SF/160	160		FPPVBRDINSF/090	90
	FPPVBR150SF/225	225		FPPVBRDINSF/110	110
	FPPVBR150SF/280	280		FPPVBRDINSF/140	140
	FPPVBR150SF/315	315		FPPVBRDINSF/280	280
				FPPVBRDINSF/315	315



Backing Rings

AND DRESSING SETS

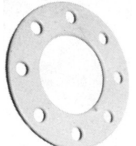
FBE COATED BACKING RINGS FOR PE

	Code	Size (OD) mm
FBE Coated Backing Ring for PE 4087 PN16 Drilling 	FPEBRNTD/063	63
	*FPEBRNTD/090	90
	FPEBRNTD/110	110
	FPEBRNTD/125	125
	FPEBRNTD/160	160
	FPEBRNTD/180	180
	FPEBRNTD/225	225
	FPEBRNTD/250	250
	FPEBRNTD/315	315
	FPEBRNTD/355	355
	FPEBRNTD/400	400
	FPEBRNTD/450	450
	FPEBRNTD/500	500
FPEBRNTD/560	560	
FPEBRNTD/630	630	
*Multi drilling includes 3/12" Hydrant drilling		
FBE Coated Backing Ring for PE Table E Drilling 	FPEBRNTE/160	160
	FPEBRNTE/180	180
	FPEBRNTE/200	200
	FPEBRNTE/250	250
	FPEBRNTE/315	315



DRESSING SETS FOR PE

	Code	Size (OD) mm	Bolt Length mm
Dressing Set 316SS Bolts Table D EPDM Gasket 	FPEHDRESS316TD/063	63	75
	FPEHDRESS316TD/075	75	75
	FPEHDRESS316TD/090	90	90
	FPEHDRESS316TD/110	110	90
	FPEHDRESS316TD/125	125	90
	*FPEHDRESS316TD/140	140	90
	FPEHDRESS316TD/160	160	110
	FPEHDRESS316TD/180	180	110
	FPEHDRESS316TD/200	200	110
	FPEHDRESS316TD/225	225	110
	FPEHDRESS316TD/250	250	110
	FPEHDRESS316TD/280	280	110
	FPEHDRESS316TD/315	315	130
	FPEHDRESS316TD/355	355	130
	* Table D/E		
Dressing Set Galv Bolts Table D EPDM Gasket 	FPEHDRESSGTD/063	63	75
	FPEHDRESSGTD/075	75	75
	FPEHDRESSGTD/090	90	90
	FPEHDRESSGTD/110	110	90
	FPEHDRESSGTD/125	125	90
	*FPEHDRESSGTD/140	140	90
	FPEHDRESSGTD/160	160	110
	FPEHDRESSGTD/180	180	110
	FPEHDRESSGTD/200	200	110
	FPEHDRESSGTD/225	225	110
	FPEHDRESSGTD/250	250	110
	FPEHDRESSGTD/280	280	110
	FPEHDRESSGTD/315	315	130
	FPEHDRESSGTD/355	355	130
	* Table D/E		

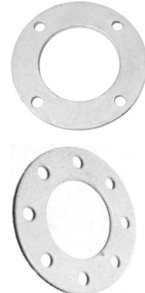
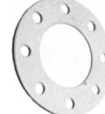
GALVANISED BACKING RINGS FOR PE

	Code	Size (OD) mm
Galvanised Backing Ring for PE 4087 PN16 Drilling 	FPEBRGTD/032	32
	FPEBRGTD/040	40
	FPEBRGTD/050	50
	FPEBRGTD/063	63
	FPEBRGTD/075	75
	FPEBRGTD/090	90
	FPEBRGTD/110	110
	FPEBRGTD/125	125
	FPEBRGTD/140	140
	FPEBRGTD/160	160
	FPEBRGTD/180	180
	FPEBRGTD/200	200
	FPEBRGTD/225	225
	FPEBRGTD/250	250
	FPEBRGTD/280	280
	FPEBRGTD/315	315
	FPEBRGTD/355	355
	FPEBRGTD/400	400
	FPEBRGTD/450	450
	FPEBRGTD/500	500
	FPEBRGTD/560	560
	FPEBRGTD/630	630
	FPEBRGTD/710	710
	FPEBRGTD/800	800
FPEBRGTD/900	900	
FPEBRGTD/1000	1000	
FPEBRGTD/1200	1200	
Galvanised Backing Ring for PE Table E Drilling 	FPEBRGTE/160	160
	FPEBRGTE/180	180
	FPEBRGTE/200	200
	FPEBRGTE/225	225
	FPEBRGTE/250	250
	FPEBRGTE/280	280
FPEBRGTE/315	315	
FPEBRGTE/450	450	

SS 316 BACKING RINGS FOR PE

	Code	Size (OD) mm	
SS 316 Backing Ring for PE, 4087 PN16 Drilling 	FPEBRSSSTD/090	90	
	FPEBRSSSTD/110	110	
	FPEBRSSSTD/125	125	
	FPEBRSSSTD/160	160	
	FPEBRSSSTD/180	180	
	FPEBRSSSTD/225	225	
	FPEBRSSSTD/250	250	
	FPEBRSSSTD/315	315	
	FPEBRSSSTD/355	355	
	FPEBRSSSTD/400	400	
	FPEBRSSSTD/450	450	
	FPEBRSSSTD/500	500	
	FPEBRSSSTD/630	630	
	FPEBRSSSTD/710	710	
	FPEBRSSSTD/800	800	
	FPEBRSSSTD/900	900	
	SS 316 Backing Ring for PE Table E Drilling 	FPEBRSSSTE/160	160
		FPEBRSSSTE/280	280
FPEBRSSSTE/450		450	
FPEBRSSSTE/560		560	